

FIG. 1

FIG. 2

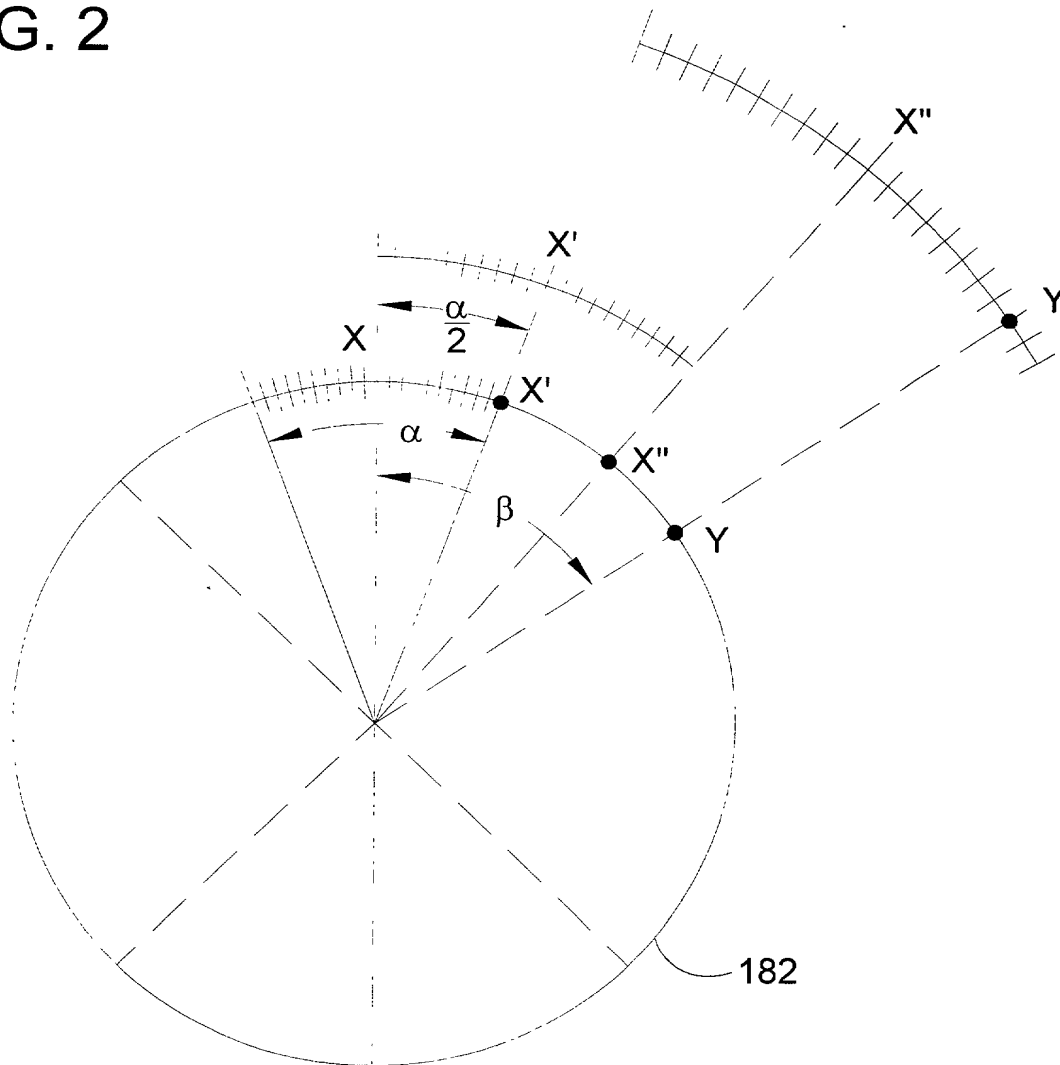

FIG. 2

FIG. 3

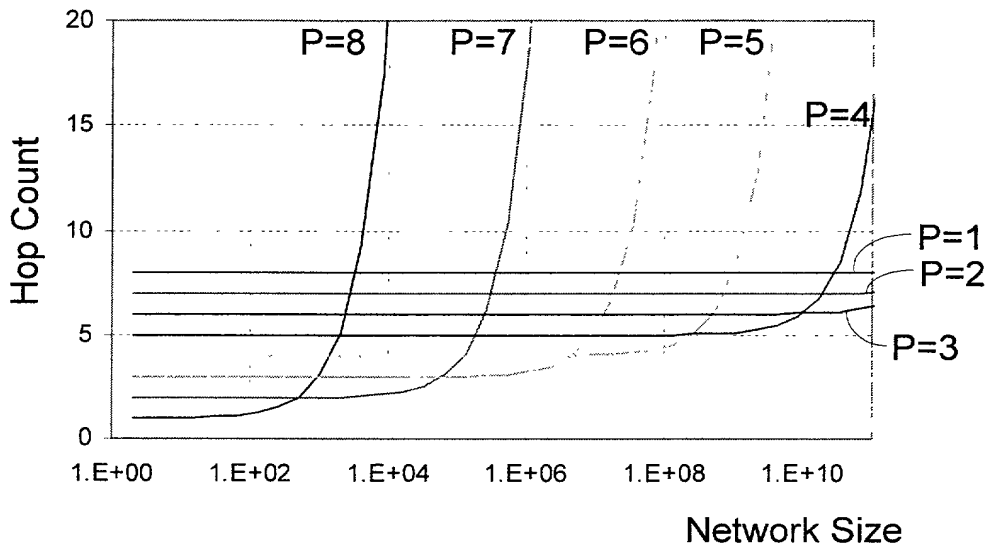
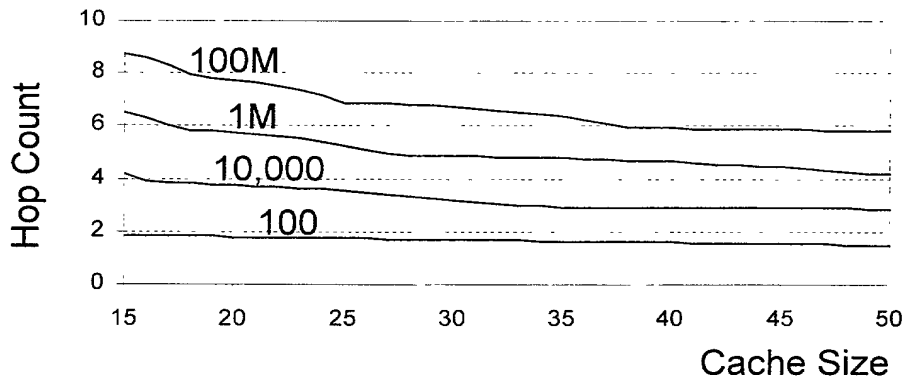
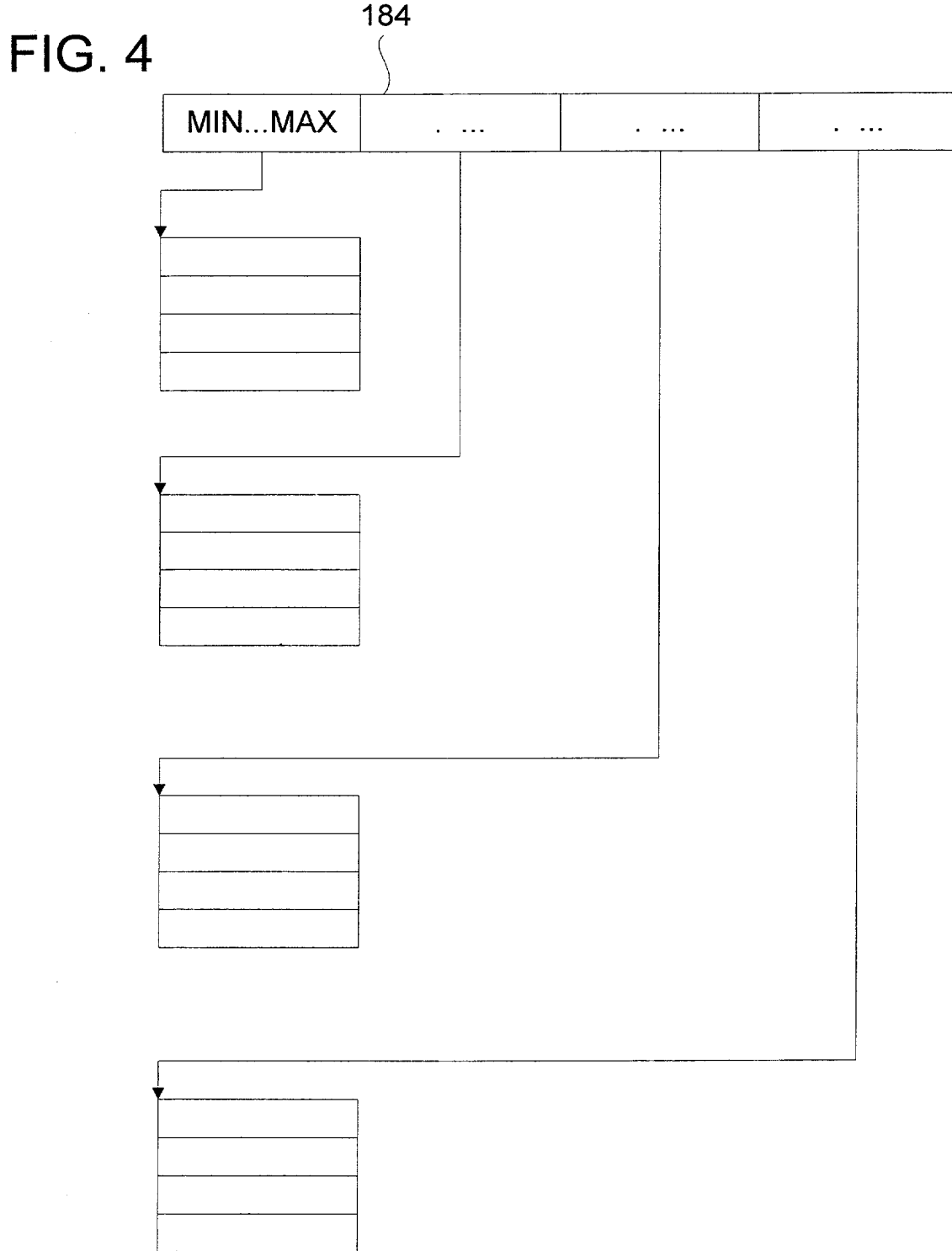

FIG. 5





Attorney Docket 209196

FIG. 6

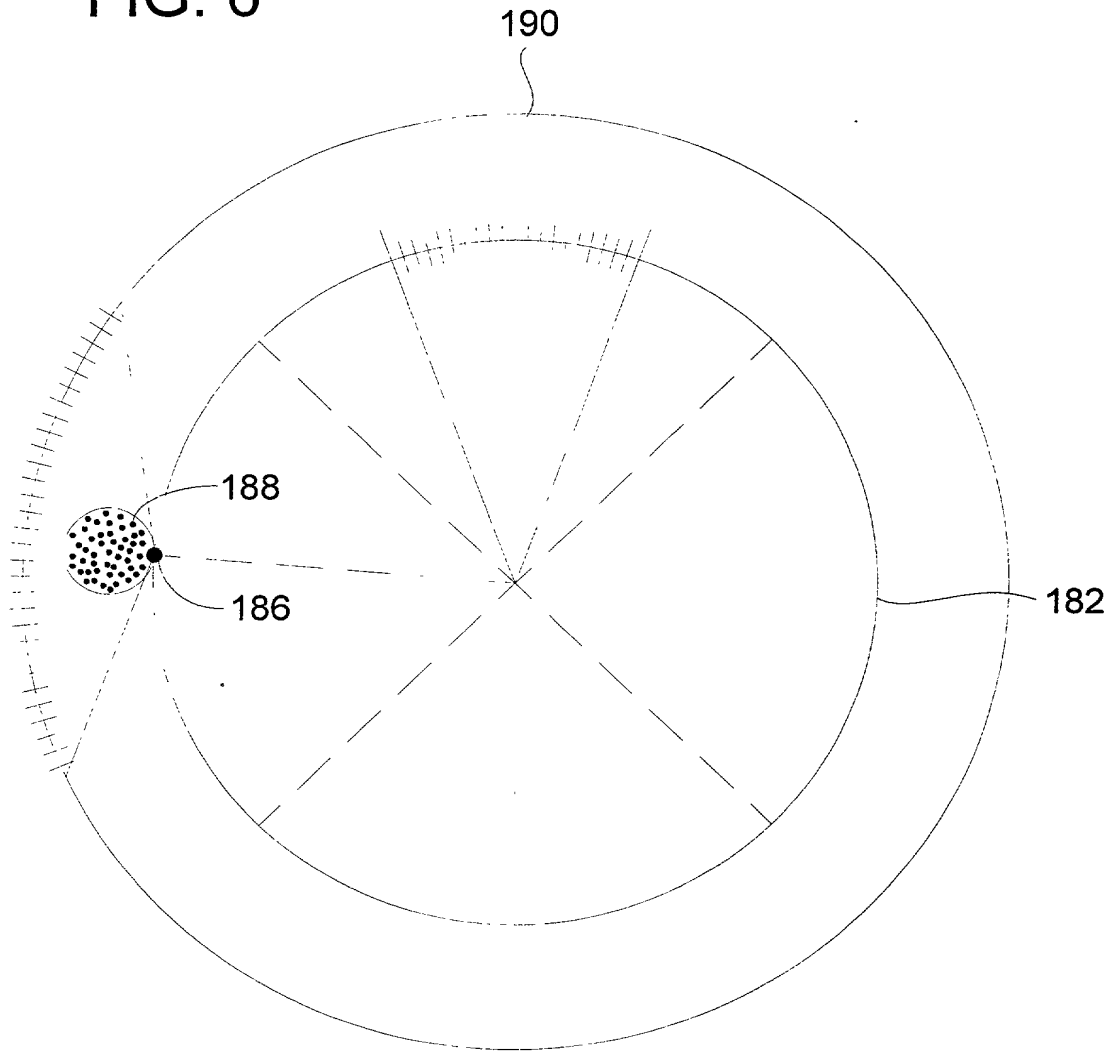

Attorney Docket 209196, Telephone (312) 616-5600

FIG. 7

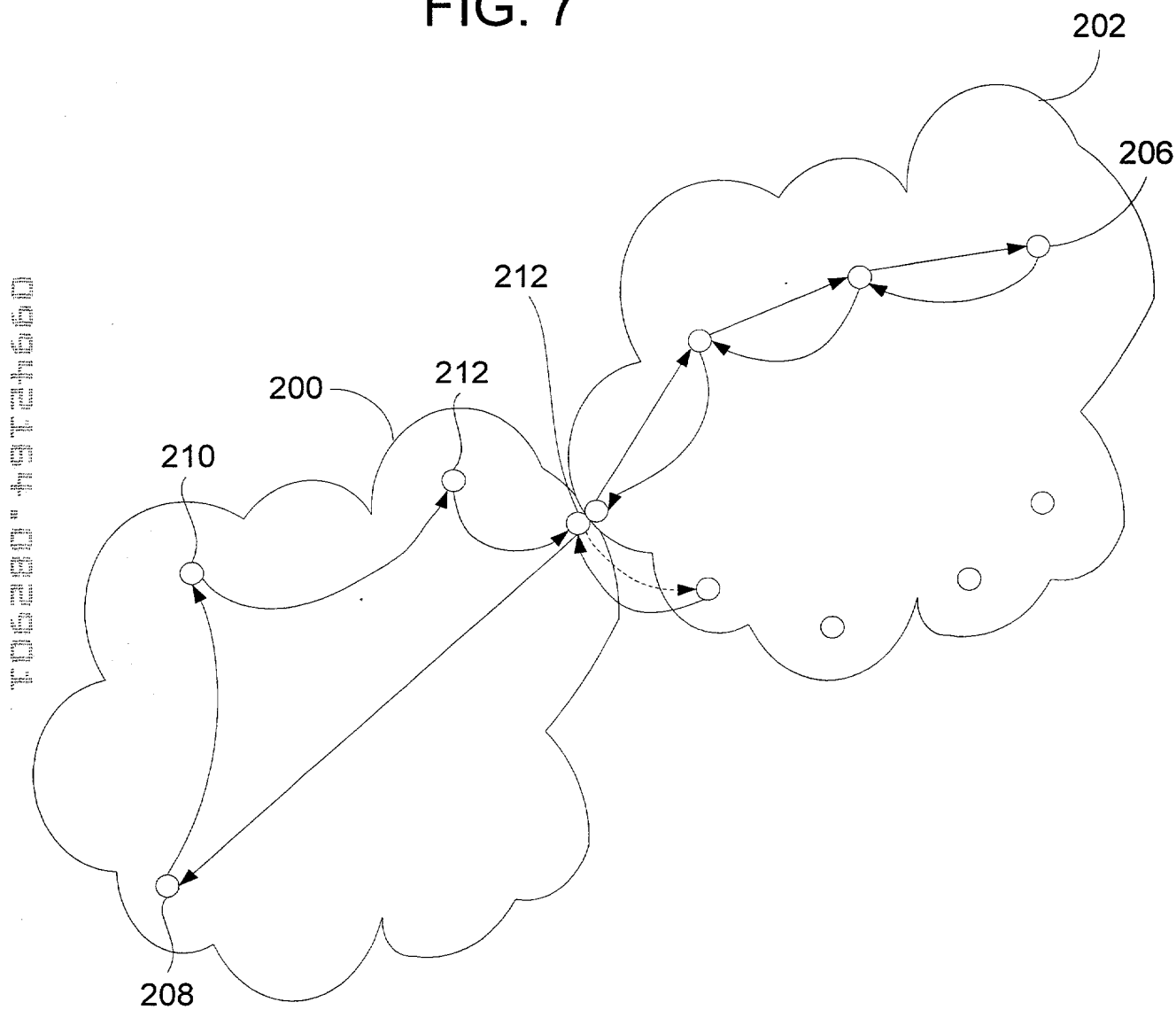
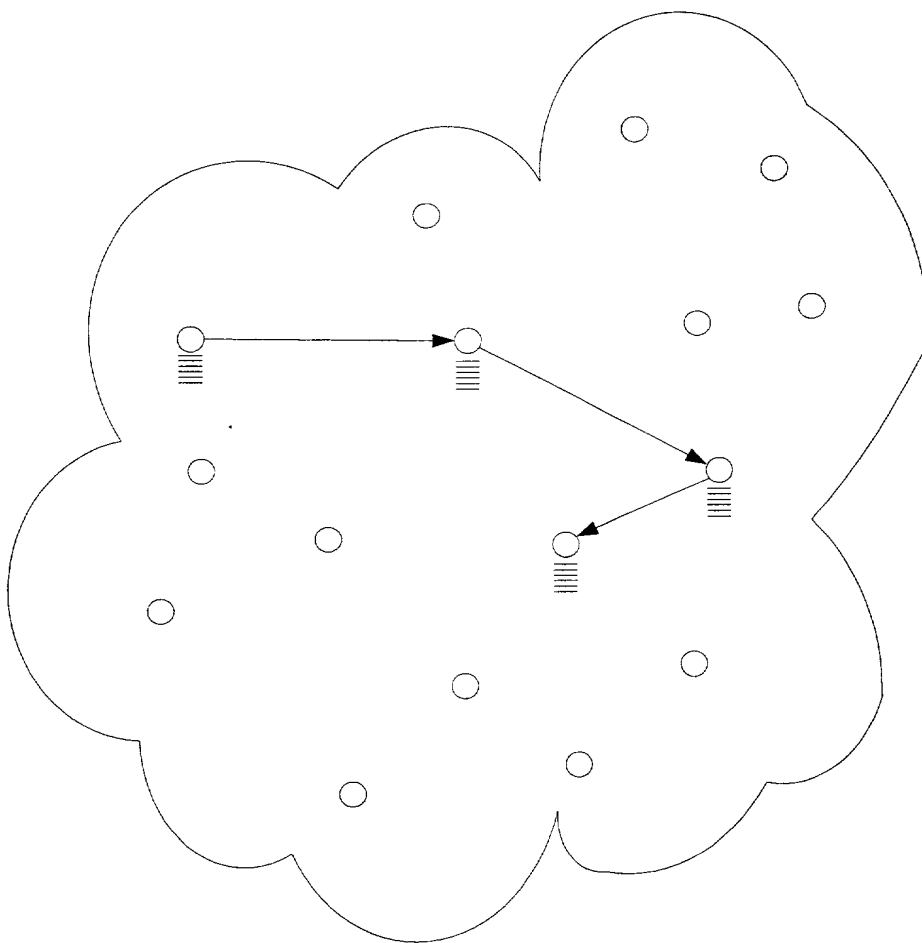

FIG. 8



616-5600 209196